

KIRBY INLAND MARINE

CARGO TRANSFER PROCEDURES FOR THE BARGE

KIRBY 16806

PLEASE NOTE:

FOR PROPER VALVE ALIGNMENT AND SAFE CARGO TRANSFER GUIDANCE, PLEASE REFER TO KIRBY MARINE TRANSPORTATION'S CARGO HANDLING PROCEDURE MANUAL AND FOLLOW THE KIRBY TRANSFER PLAN.

IF YOU NEED A COPY OF THE PROCEDURE MANUAL, PLEASE CALL THE KIRBY DUTY LINE (713) 435-1618 OR (713) 435-1925 BEFORE CARGO OPERATION.

TABLE OF CONTENTS

SECTION#	TITLE	PAGE
155.750(a)(1):	Chemical Information	3
155.750(a)(2):	Piping Diagram	25
155.750(a)(3):	Number of Persons on Duty	28
155.750(a)(4):	Duties of Tankerman (Person in Charge)	29
155.750(a)(5):	Tending Moorings During Transfer	32
155.750(a)(6):	Emergency Shutdown and Communications	33
155.750(a)(7):	Procedures for Topping Off Tanks and Discharge Operations	34
155.750(a)(8):	Control Valve Operation & Closure	44
155.750(a)(9):	Procedures for Reporting Discharges	45
155.750(a)(10):	Procedures for Closing and Opening the Vessel Openings	47
155.750(a)(11):	Hoses	48

SECTION 155.750 (a)(1):

CHEMICAL INFORMATION

This section complies with 33 CFR 155.750 (a) with regard to the chemical information provided for the following liquefied gases:

BUTADIENE

BUTANE

ISOBUTANE

BUTYLENE (Butene)

ISOBUTYLENE

LIQUIFIED PETROLEUM GAS

PROPANE

PROPYLENE

MISTURES OF THE ABOVE (excluding any mixtures containing butadiene)

The information in the following pages for each cargo is represented jointly in the following manner:

1. Data sheet from CHRIS Manual and Chemical Data Guide (CDG)
2. Tables of vapor pressure and temperature data from Matheson Gas Data Book.
3. Graph of vapor pressure vs. temperature from Matheson Gas Data Book.

The information in these procedures will assist the PIC in determining chemical properties for personal protection, response, etc. as well as to provide needed guidance on pressure/temperature relationships and load limits.

The Material Safety Data Sheet (MSDS) is the most accurate source of information for the particular cargo involved in the transfer. For example, all generic sources in CHRIS, CDG, etc. will state that butadiene must be inhibited, but only the specific MSDS for the butadiene involved in the transfer will state whether or not it actually is inhibited. This is critical, and mistakes have been made in the past when the PIC does not check the MSDS for specifics.

Under the "Right to Know" laws, the PIC has a right to ask the terminal to view the MSDS. Do so!

BUTADIENE

<p>Synonyms—Diethylene; Blvinyl; 1,3-Butadiene; alpha, gamma-Butadiene; Divinyl; Erythrene; Pyrrolylene; Vinyl ethylene</p> <p>Formula—C₄H₆, or CH₂ = CHCH = CH₂</p> <p>Appearance-Odor—Colorless gas or liquid; mild, aromatic odor</p> <p>Specific Gravity—0.82 at 20°C (a liquid)</p> <p>Chemical Family—Unsaturated hydrocarbon</p> <p>Pollution Category—USEPA _____ IMO <u>099</u></p> <p>Applicable Bulk Reg. 46 CFR Subchapter _____ <u>Q</u></p>	<p>United Nations Number..... <u>1010</u></p> <p>CHRIS Code..... <u>BDI</u></p> <p>Boiling Point..... <u>-4°C</u> <u>24°F</u></p> <p>Freezing Point..... <u>-109°C</u> <u>-164°F</u></p> <p>Vapor Pressure 20°C (68°F) (mmHg)..... <u>1789</u></p> <p>Reid Vapor Pressure (psia)..... <u>61</u></p> <p>Vapor Pressure 46°C (115°F) (psia)..... <u>75</u></p> <p>Vapor Density (Air = 1.0)..... <u>1.89</u></p> <p>Solubility in Water..... <u>Necklebits</u></p>
--	---

FIRE & EXPLOSION HAZARD DATA

Grade—Liquefied Flammable Gas (LFG)

Electrical Group—B

General—Unless flow of gas can be stopped, extinguishing a butadiene fire may permit accumulation of an explosive concentration of vapor, and subsequent explosion or re-flash. Fire may cause violent rupture of tank.

Flash Point (°F)..... -105

Flammable Limits..... 2.0 to 11.5%

Autoignition Temp. (°F)..... 842

Extinguishing Agents..... Stop flow of gas; CO₂, dry chemical, water fog

Special Fire Procedures..... Keep burning tank and adjacent tanks cool with a water spray. Wear full protective clothing and self-contained breathing apparatus.

HEALTH HAZARD DATA

Health Hazard Ratings	Odor Threshold (ppm)	PEL/TWA (ppm)	TLV/TWA (ppm)
1,1,1	above 1000	unavailable	1000

General—Suspected carcinogen. Liquid or cold gas may cause skin or eye injury similar to frostbite.

Symptoms—Inhalation: dizziness, headache. Skin contact: frostbitten areas will appear white. Irritating to eyes and respiratory tract.

Short Exposure Tolerance—8,000 ppm was found endurable for 8 hours with only slight irritation of the eyes and upper respiratory tract.

Exposure Procedures—Vapor—remove victim to fresh air; if breathing stops, apply artificial respiration. Skin or eye contact—remove contaminated clothing and gently flush affected areas with water for 15 minutes. Protect frostbitten areas from abrasions and mechanical damage. DO NOT RUB. Get medical advice or attention.

REACTIVITY DATA

Stability—Must be inhibited to prevent polymerization. Forms unstable peroxides in presence of oxygen and/or iron rust.

Compatibility—Material: Unsafe in contact with acetylide-forming materials such as monel, copper or copper alloys.

Cargo: Group 30 of compatibility chart.

SPILL OR LEAK PROCEDURE

Wear rubber gloves, face shield, protective clothing, and self-contained breathing apparatus. Secure ignition sources. The spilled liquid will boil away leaving no residue.

If a spill occurs, call the National Response Center, 800-424-8802.

Remarks:

1,3-BUTADIENE

Table 1. THERMODYNAMIC PROPERTIES OF SATURATED 1,3-BUTADIENE²

Temp., °F.	Pressure p.s.i.a.	Specific Volume Liquid cu. ft./lb.	Specific Volume Vapor cu. ft./lb.	Enthalpy		Latent Heat BTU/lb.	Entropy		Temp., °F.
				Liquid BTU/lb.	Vapor BTU/lb.		Liquid BTU/lb. °R.	Vapor BTU/lb. °R.	
-164.05	0.010	0.02097	5706	122.6	341.8	219.2	0.5904	1.3317	-164.05
-160	.013	.02104	4504	124.4	342.7	218.3	.5973	1.3256	-160
-140	.045	.02136	1406	133.5	347.3	213.8	.6267	1.2953	-140
-120	.130	.02170	516.5	142.7	352.0	209.3	.6546	1.2707	-120
-100	.329	.02205	216.7	151.9	356.9	205.0	.6810	1.2509	-100
-90	.500	.02224	146.4	156.6	359.5	202.9	.6938	1.2425	-90
-80	.740	.02242	101.44	161.3	362.0	200.7	.7062	1.2350	-80
-70	1.071	.02261	71.88	166.0	364.7	198.7	.7184	1.2283	-70
-60	1.076	.02280	52.00	170.7	367.3	196.6	.7304	1.2223	-60
-50	2.103	.02300	38.33	175.5	370.0	194.5	.7422	1.2170	-50
-40	2.867	.02320	28.75	180.3	372.7	192.4	.7538	1.2123	-40
-30	3.841	.02341	21.91	185.1	375.5	190.4	.7652	1.2081	-30
-20	5.068	.02362	16.94	190.0	378.2	188.2	.7764	1.2045	-20
-10	6.592	.02384	13.27	194.9	381.0	186.1	.7875	1.2013	-10
0	8.461	.02406	10.525	199.9	383.9	184.0	.7984	1.1985	0
10	10.728	.02429	8.441	205.0	386.7	181.7	.8092	1.1962	10
20	13.45	.02453	6.840	210.1	389.6	179.5	.8199	1.1942	20
30	16.68	.02478	5.595	215.2	392.4	177.2	.8305	1.1925	30
40	20.49	.02503	4.617	220.4	395.3	174.9	.8410	1.1910	40
50	24.94	.02529	3.840	225.7	398.2	172.5	.8514	1.1899	50
60	30.11	.02557	3.218	231.0	401.1	170.1	.8617	1.1890	60
70	36.05	.02585	2.715	236.4	404.0	167.6	.8719	1.1883	70
80	42.84	.02614	2.305	241.9	406.8	164.9	.8821	1.1878	80
90	50.57	.02645	1.968	247.4	409.7	162.3	.8922	1.1874	90
100	59.30	.02678	1.689	253.0	412.5	159.5	.9023	1.1872	100
120	80.11	.02747	1.262	264.6	418.2	153.6	.9223	1.1873	120
140	105.93	.02823	0.9576	276.4	423.6	147.2	.9422	1.1877	140
160	137.4	.02909	.7362	288.6	428.9	140.3	.9620	1.1883	160
180	175.4	.03007	.5715	301.3	433.9	132.6	.9817	1.1891	180
200	220.5	.03121	.4465	315	439.0	124.0	1.001	1.190	200
220	266		.3275						

235

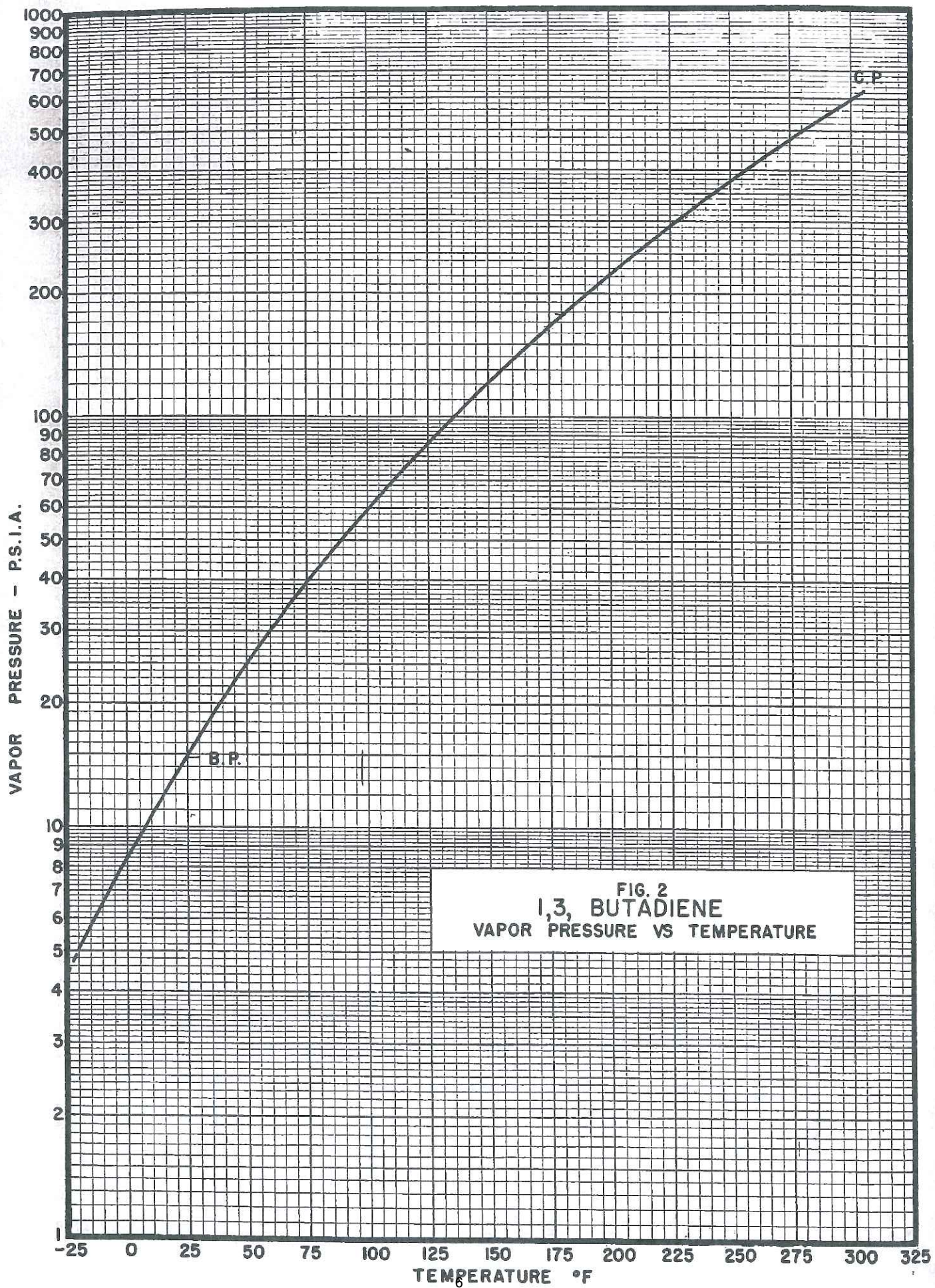

FIG. 2
1,3, BUTADIENE
VAPOR PRESSURE VS TEMPERATURE

n-BUTANE

Synonyms—Butane; Diethyl; Methyl ethylmethane Formula—C ₄ H ₁₀ Appearance—Odor—Colorless; odorless gas Specific Gravity—0.58 at 0°C (a liquid) Chemical Family—Saturated hydrocarbon Pollution Category—USEPA _____ IMO <u>988</u> Applicable Bulk Reg. 46 CFR Subchapter _____ <u>D.O</u>	United Nations Number..... <u>1011</u> CHRIS Code..... <u>BUT</u> "iso. n-" <u>BMX</u> Boiling Point..... <u>-0.5°C</u> <u>31°F</u> Freezing Point..... <u>-138°C</u> <u>-217°F</u> Vapor Pressure 20°C (68°F) (mmHg)..... <u>1530</u> Reid Vapor Pressure (psia)..... <u>52.4</u> Vapor Pressure 46°C (115°F) (psia)..... <u>86.0</u> Vapor Density (Air = 1.0)..... <u>2.07</u> Solubility in Water..... <u>insoluble</u>
--	---

FIRE & EXPLOSION HAZARD DATA

Grade—Liquefied Flammable Gas (LFG)
 Electrical Group—D

General—Unless the flow of gas can be stopped, extinguishing a butane fire will permit accumulation of an explosive concentration of vapor, and subsequent explosion or re-flash.

Flash Point (°F)..... -76
 Flammable Limits..... 1.9 to 8.5%
 Autoignition Temp. (°F)..... 781
 Extinguishing Agents..... Stop flow of gas; CO₂, dry chemical, water fog.
 Special Fire Procedures..... Keep burning tank and adjacent tanks cool with a water spray. Stop flow of gas.

HEALTH HAZARD DATA

Health Hazard Ratings	Odor Threshold (ppm)	PEL/TWA (ppm)	TLV/TWA (ppm)
0, 0, 0	5000	800	800

General—Produces drowsiness. Simple asphyxiant. Liquid or cold gas may cause frostbite.

Symptoms—Dizziness and drowsiness.

Short Exposure Tolerance—10,000 ppm (1%) for 10 minutes will cause drowsiness.

Exposure Procedures—Remove victim to fresh air. If breathing has stopped, give artificial respiration. If the liquid has spilled onto the skin, points of contact may be frostbitten; handle gently and protect from mechanical damage. DO NOT RUB. Get medical attention.

REACTIVITY DATA

Stability—Stable product.

Compatibility—Material: Non-corrosive to most materials of construction.

Cargo: Group 31 of compatibility chart.

SPILL OR LEAK PROCEDURE

Wear rubber gloves, face shield, protective clothing. Have all-purpose canister mask available. Secure ignition sources. The spilled liquid will boil away rapidly, leaving no residue.

If a spill occurs, call the National Response Center, 800-424-8802.

Remarks:

BUTANE

REFERENCES

¹Sage, Webster and Lacey, *Ind. Eng. Chem.*, 29, 1188 (1937).

²Rodd, E. H., Editor, *Chemistry of Carbon Compounds*, Elsevier Publishing Co., New York, N. Y., 1951, IA, pp. 230-248.

³Lipkin, M. R., Davidson, J. A., and Kurtz, S. S., Jr., *Ind. Eng. Chem.* 34, 978 (1942).

FURTHER DATA REFERENCES

Beattie, J., Stockmayer, W., and Ingersoll, H., *The Compressibilities of Gaseous Mixtures of Methane and Normal Butane*, *J. Chem. Phys.* 9, 871 (1941).

Table 1. THERMODYNAMIC PROPERTIES OF SATURATED n-BUTANE¹

Temp. °F.	Pressure p.s.i.a.	Specific Volume Liquid cu.ft./lb.	Specific Volume Vapor cu.ft./lb.	Enthalpy		Latent Heat BTU/lb.	Entropy		Temp. °F.
				Liquid BTU/lb.	Vapor BTU/lb.		Liquid BTU/lb. °R.	Vapor BTU/lb. °R.	
67.6	30	0.02747	3.027	4.20	163.88	159.68	0.0106	0.3108	67.6
84.3	40	.02802	2.301	13.80	169.11	155.31	.0284	.3116	84.3
98.0	50	.02850	1.8568	22.09	173.51	151.42	.0407	.3124	98.0
109.7	60	.02891	1.5556	29.29	177.22	147.93	.0527	.3132	109.7
115 120.1	70	.02926	1.3377	35.65	180.49	144.84	.0639	.3142	120.1
129.3	80	.02960	1.1728	41.50	183.38	141.88	.0741	.3152	129.3
137.7	90	.02993	1.0433	46.80	186.00	139.20	.0834	.3161	137.7
145.5	100	.03025	0.9393	51.89	188.42	136.53	.0919	.3172	145.5
162.6	125	.03104	.7492	63.70	193.77	130.07	.1105	.3196	162.6
177.3	150	.03183	.6203	74.30	198.33	124.03	.1267	.3218	177.3
190.3	175	.03264	.5259	83.17	202.14	118.97	.1408	.3237	190.3
202.0	200	.03342	.4536	91.55	205.29	113.74	.1534	.3252	202.0
212.7	225	.03422	.3959	99.40	207.88	108.48	.1646	.3261	212.7
222.5	250	.03497	.3489	106.68	209.97	103.29	.1755	.3267	222.5
231.7	275	.03580	.3095	113.63	211.68	98.05	.1856	.3270	231.7
240.2	300	.03671	.2761	120.37	212.97	92.60	.1950	.3270	240.2

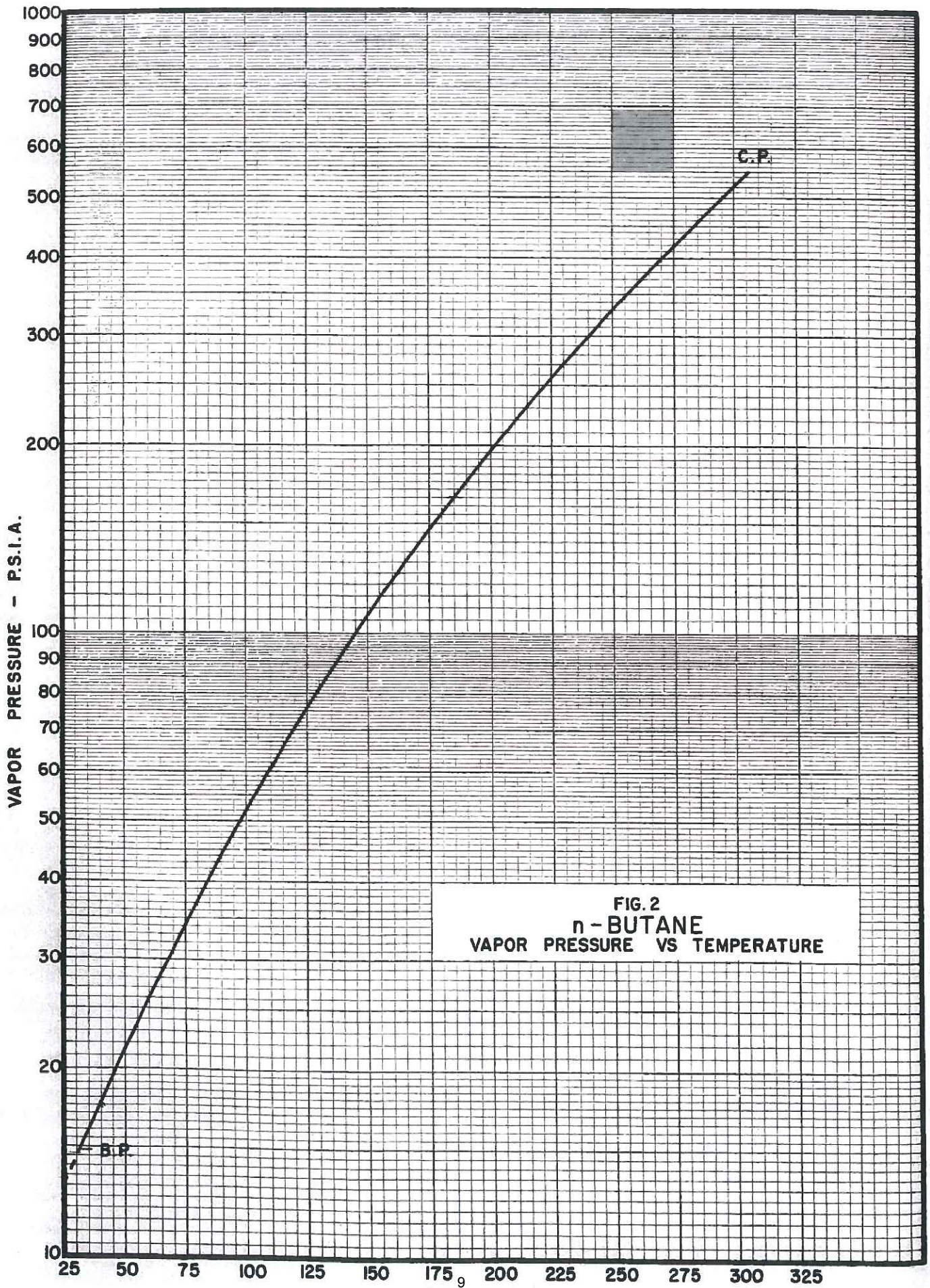

ISOBUTANE

Table 1. THERMODYNAMIC PROPERTIES OF SATURATED ISOBUTANE¹

Temp. °F.	Pressure p.s.i.a.	Specific Volume Liquid cu. ft./lb.	Specific Volume Vapor cu. ft./lb.	Enthalpy		Latent Heat BTU/lb.	Entropy		Temp. °F.
				Liquid BTU/lb.	Vapor BTU/lb.		Liquid BTU/lb. °R.	Vapor BTU/lb. °R.	
63.0	40	0.02838	2.210	1.64	146.4	144.76	0.0032	0.2803	63.0
76.5	50	.02888	1.7813	9.30	151.11	141.81	.0173	.2818	76.5
88.1	60	.02932	1.4904	16.01	154.82	138.81	.02957	.2831	88.1
98.2	70	.02973	1.2796	21.96	157.97	136.01	.0403	.2841	98.2
107.3	80	.03013	1.1198	27.34	160.81	133.47	.0499	.2852	107.3
115.5	90	.03049	0.9947	32.37	163.33	130.96	.0586	.2862	115.5
123.8	100	.03088	.8949	37.57	165.73	128.16	.0674	.2871	123.8
139.8	125	.03167	.7103	47.89	170.44	122.55	.0844	.2889	139.8
154.2	150	.03245	.5864	57.36	174.49	117.13	.0998	.2906	154.2
167.0	175	.03331	.4979	66.06	178.03	111.97	.1136	.2923	167.0
178.3	200	.03412	.4305	73.94	181.0	107.06	.1259	.2938	178.3
188.7	225	.03496	.3769	81.42	183.8	102.38	.1373	.2951	188.7
198.3	250	.03578	.3327	88.51	185.8	97.29	.1478	.2957	198.3
207.3	275	.03663	.2954	95.26	187.3	92.04	.1578	.2959	207.3
215.6	300	.03748	.2633	101.7	188.7	87.0	.1671	.2959	215.6
223.5	325	.03838	.2325	108.0	189.6	81.6	.1760	.2954	223.5
231.0	350	.03935	.2110	114.1	189.6	75.5	.1846	.2941	231.0
238.1	375	.04036	.1888	120.1	189.5	69.4	.1928	.2920	238.1
244.9	400	.04143	.1686	126.1	189.7	63.6	.2009	.2897	244.9

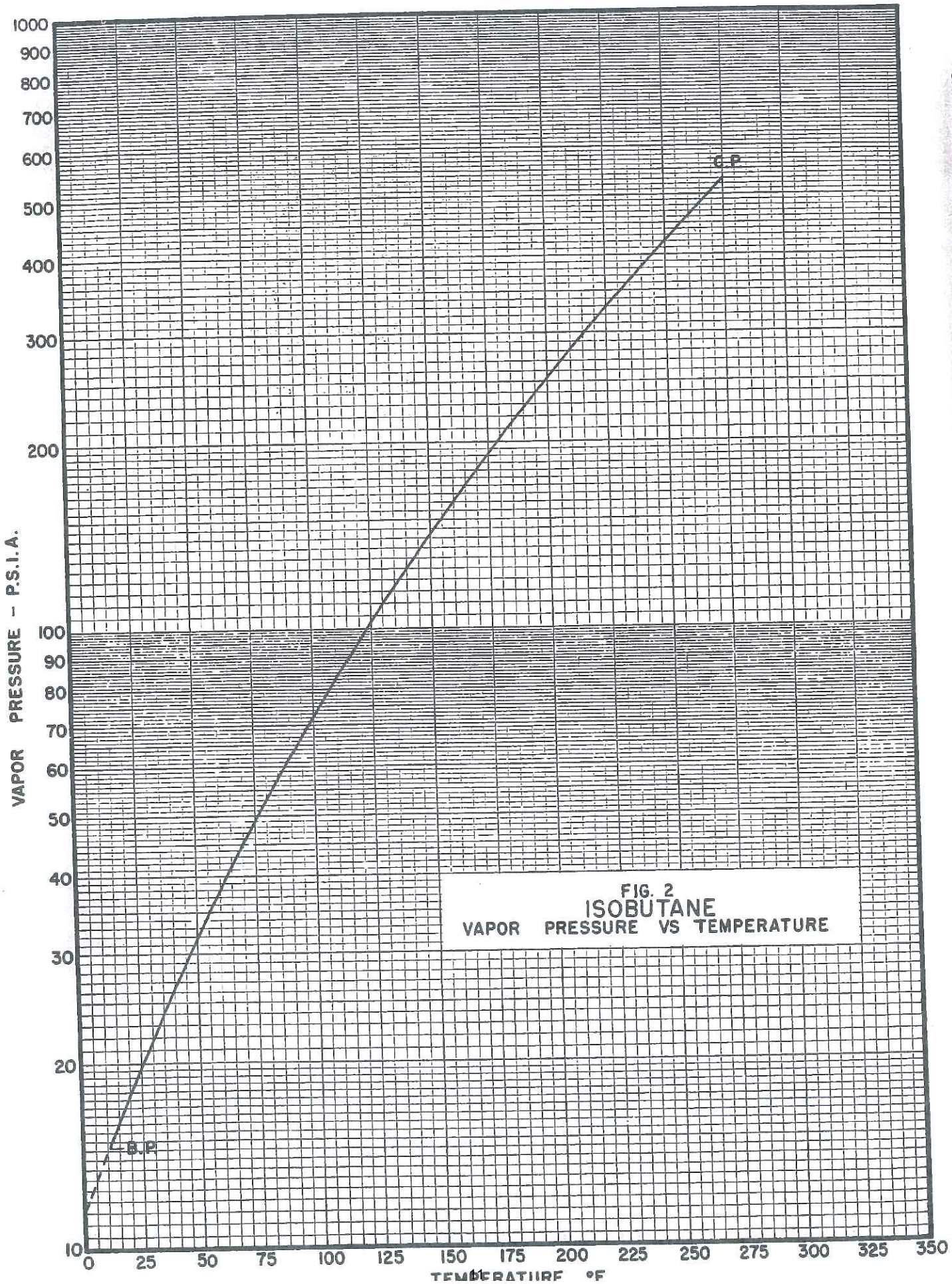

BUTYLENE

Synonyms—Butene; 1-Butene; alpha-Butylene;
Ethylethylene

United Nations Number..... 1012

CHRIS Code..... BTN

Formula— $\text{CH}_2 = \text{CHCH}_2\text{CH}_3$

Appearance—Odor—Colorless gas; sweetish odor

Boiling Point..... -8°C 21°F

Freezing Point..... -186°C -302°F

Specific Gravity—0.80 at 20°C (a liquid)

Chemical Family—Olefin

Vapor Pressure 20°C (68°F) (mmHg)..... 1030

Reid Vapor Pressure (psia)..... 82.5

Vapor Pressure 46°C (115°F) (psia)..... 78

Vapor Density (Air = 1.0)..... 1.84

Solubility in Water..... insoluble

Pollution Category—USEPA..... IMO 088

Applicable Bulk Reg. 46 CFR Subchapter..... D.O.

FIRE & EXPLOSION HAZARD DATA

Grade—Liquefied Flammable Gas (LFG)

Electrical Group—D

General—Unless the flow of gas can be stopped, extinguishing a butene fire will permit accumulation of an explosive concentration of vapor, and subsequent explosion or re-flash.

Flash Point (°F)..... 110 (cc)

Flammable Limits..... 1.6 to 9.3%

Autoignition Temp. (°F)..... 723

Extinguishing Agents..... Stop flow of gas; CO_2 , dry chemical, water fog.

Special Fire Procedures..... Keep burning tank and adjacent tanks cool with a water spray.

HEALTH HAZARD DATA

Health Hazard Ratings	Odor Threshold (ppm)	PEL/TWA (ppm)	TLV/TWA (ppm)
Unavailable	Unavailable	Unavailable	Unavailable

General—May produce anesthetic effects on exposure to high vapor concentrations. Contact with liquid may produce a frostbite.

Symptoms—Breathing high concentrations of gas for some time may cause dizziness. Contact with liquid may cause skin and eye injury similar to frostbite.

Short Exposure Tolerance—Unavailable

Exposure Procedures—Remove to fresh air. If breathing has stopped, give artificial respiration. If the liquid has spilled onto the skin, points of contact may be frostbitten; handle gently and protect from mechanical damage. DO NOT RUB. Get medical attention.

REACTIVITY DATA

Stability—Stable. Can react with oxidizing materials.

Compatibility—Material: Noncorrosive to most materials of construction.

Cargo: Group 30 of compatibility chart.

SPILL OR LEAK PROCEDURE

Wear rubber gloves, face shield, protective clothing. Have all-purpose canister mask available. Secure ignition sources. The spilled liquid will boil away rapidly, leaving no residue.

If a spill occurs, call the National Response Center, 800-424-8802.

Remarks:

1-BUTENE

Vapor Pressure¹

The vapor pressure of 1-butene up to 1 atm. is as follows:

Temperature °C.	Pressure mm. Hg
-104.8	1
-89.4	5
-81.6	10
-73.0	20
-63.4	40
-57.2	60
-48.9	100
-36.2	200
-21.7	400
-6.3	760

Vapor pressures above 1 atm. may be obtained from Table 1 on Thermodynamic Properties of Saturated 1-Butene or from the vapor pressure curve, Figure 2.

REFERENCES

¹Perry, John H., Editor-in-Chief, *Chemical Engineers' Handbook*, 3rd Edition, McGraw-Hill Book Co., New York, N. Y., 1950 p. 154. Compiled from extended tables published by D. R. Stull in *Ind. Eng. Chem.*, 39, 517 (1947).

²Weber, J., *A.I.Ch.E. Journal* 1, 210 (1955).

OTHER DATA

Kilpatrick, J., and Pitzer, K., *Heat Content, Free Energy Function, Entropy, and Heat Capacity of Ethylene, Propylene, and the Four Butenes to 1500°K.*, Research Natl. Bur. Standards 37, 163 (1946).

Wacker, P., Cheney, R., and Scott, R., *Heat Capacities of Gaseous Oxygen, Isobutane, and 1-Butene from -30 to 90°C.*, J. Research Natl. Bur. Standards 38, 651 (1947).

Table 1. THERMODYNAMIC PROPERTIES OF SATURATED 1-BUTENE²

Temp., °F.	Pressure p.s.i.a.	Specific Volume Liquid cu. ft./lb.	Specific Volume Vapor cu. ft./lb.	Enthalpy		Latent Heat BTU/lb.	Entropy		Temp., °F.
				Liquid BTU/lb.	Vapor BTU/lb.		Liquid BTU/lb.°R.	Vapor BTU/lb.°R.	
32	18.64	0.02588	4.79	0.0	166.1	166.1	0.0000	0.3378	32
40	21.91	.02610	4.19	3.4	168.3	164.9	.0068	.3368	40
50	26.60	.02638	3.52	8.4	171.4	163.0	.0167	.3365	50
60	32.0	.02667	2.89	13.6	174.4	160.8	.0268	.3365	60
70	38.2	.02698	2.41	19.2	177.5	158.3	.0375	.3365	70
80	45.2	.02730	2.25	25.4	180.5	155.1	.0491	.3365	80
90	53.1	.02770	1.76	31.2	183.7	152.5	.0597	.3371	90
100	62.5	.02811	1.52	37.0	186.7	149.7	.0702	.3377	100
110	72.1	.02852	1.33	42.9	189.6	146.7	.0806	.3381	110
120	83.5	.02898	1.16	48.7	192.5	143.8	.0907	.3388	120
130	96.3	.02943	1.01	54.4	195.2	140.8	.1007	.3395	130
140	110.2	.02992	0.875	60.5	198.5	138.0	.1107	.3408	140
150	125.5	.03042	.768	66.6	201.5	134.9	.1207	.3420	150
160	142.4	.03091	.676	72.7	204.4	131.7	.1307	.3432	160
170	161.3	.03145	.595	79.0	207.5	128.5	.1409	.3450	170
180	182.0	.03202	.524	85.5	210.4	124.9	.1511	.3463	180
190	204.7	.03261	.463	92.2	213.1	120.9	.1615	.3476	190
200	228.6	.03328	.409	99.1	215.9	116.8	.1721	.3492	200
210	254.6	.03399	.364	106.4	218.6	112.2	.1831	.3506	210
220	282.8	.03477	.324	114.1	221.2	107.1	.1944	.3520	220
230	313.4	.03567	.286	122.0	223.4	101.4	.2059	.3529	230
240	346.4	.03671	.251	130.0	225.2	95.2	.2174	.3535	240
250	382.5	.03800	.219	138.4	226.7	88.3	.2293	.3537	250
260	421.3	.03962	.189	147.1	226.5	79.4	.2415	.3518	260
270	462.2	.04180	.161	158.5	226.4	67.9	.2572	.3503	270
280	505.0	.04488	.134	173.4	225.4	52.0	.2748	.3451	280

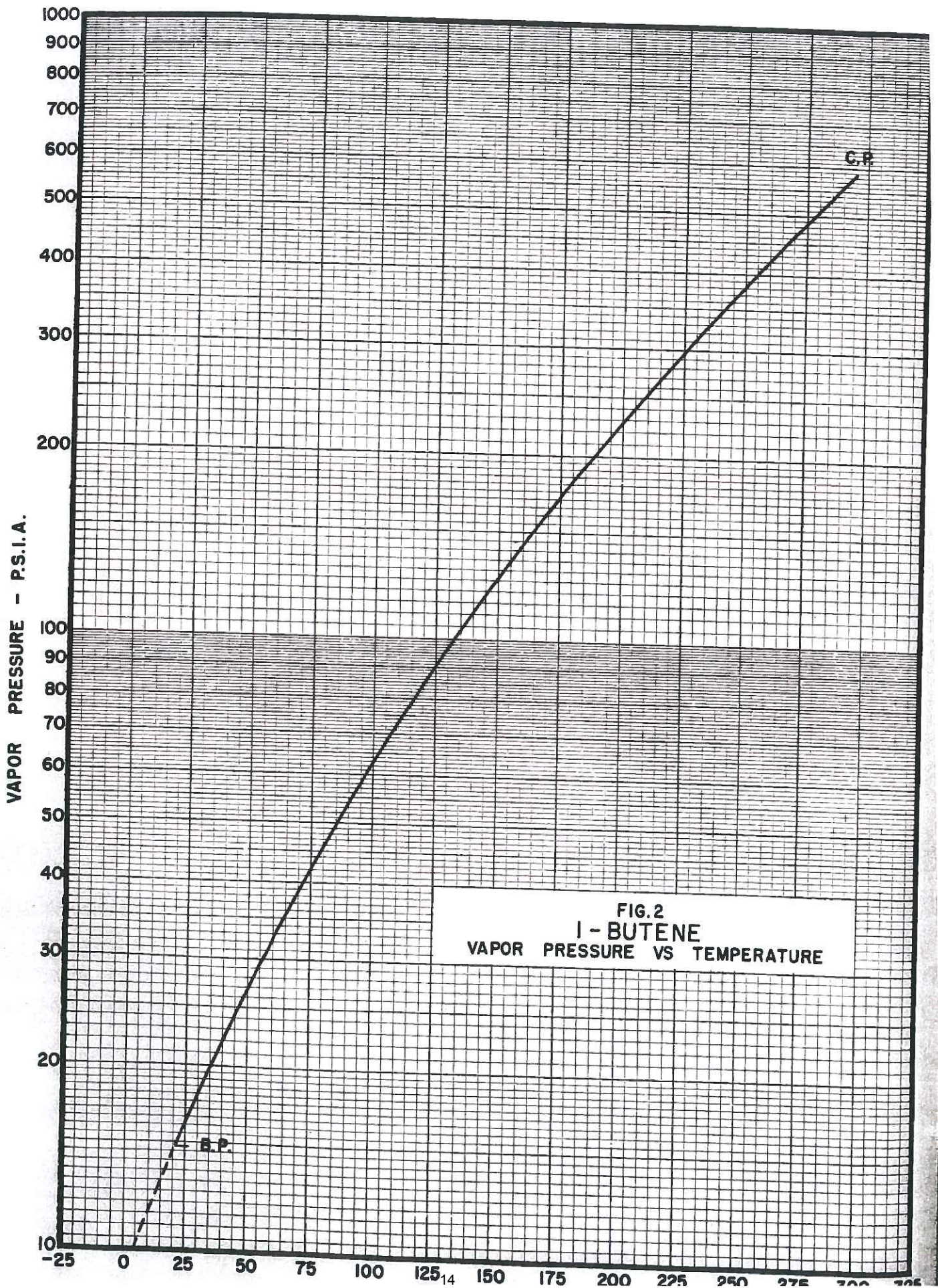

FIG. 2
1-BUTENE
VAPOR PRESSURE VS TEMPERATURE

BUTYLENE MIXTURES*

<p>Synonyms—No common synonyms.</p> <p>Formula—C₄H₈</p> <p>Appearance—Odor—Gas with gasoline-like odor.</p> <p>Specific Gravity—Unavailable</p> <p>Chemical Family—Olefins</p> <p>Pollution Category—USEPA _____ IMO <u>098</u></p> <p>Applicable Bulk Reg. 46 CFR Subchapter _____ <u>D, Q</u></p>	<p>United Nations Number..... ‡</p> <p>CHRIS Code..... ‡</p> <p>Boiling Point..... °C _____ °F _____</p> <p>Freezing Point..... °C _____ °F _____</p> <p>Vapor Pressure 20°C (68°F) (mmHg)..... _____</p> <p>Raid Vapor Pressure (psia)..... _____</p> <p>Vapor Pressure 46°C (115°F) (psia)..... _____</p> <p>Vapor Density (Air = 1.0)..... <u>1.9</u></p> <p>Solubility in Water..... <u>Insoluble</u></p>
---	---

FIRE & EXPLOSION HAZARD DATA

Grade—A: Liquefied Flammable Gas (LFG)

Electrical Group—Unassigned

General—Unless the flow of gas can be stopped, extinguishing a fire will permit the accumulation of an explosive concentration of vapor, and subsequent explosion or re-flash.

Flash Point (°F)..... -24 approximately

Flammable Limits..... 1.0 to 10.0% (approx.)

Autoignition Temp. (°F)..... 615 to 725 (approx.)

Extinguishing Agents..... Stop flow of gas; CO₂, dry chemical, water spray

Special Fire Procedures..... Use water to cool containers in order to reduce possibility of rupturing tank. Try to seal the gas leak. Use water spray to knock down water vapors. Flash back along vapor trail may occur.

HEALTH HAZARD DATA

Health Hazard Ratings 1, 4, 0	Odor Threshold (ppm) Unavailable	PEL/TWA (ppm) Unavailable	TLV/TWA (ppm) Unavailable
----------------------------------	-------------------------------------	------------------------------	------------------------------

General—Essentially non-toxic at low concentrations. At higher concentrations, it can act as an anesthetic.

Symptoms—Causes dizziness and difficult breathing. Liquid will cause frostbite.

Short Exposure Tolerance—Unavailable

Exposure Procedures—Remove victim to fresh air. If breathing has stopped, administer artificial respiration. If breathing is difficult, give oxygen. If the liquid has spilled onto the skin, points of contact may be frostbitten; handle gently and protect from mechanical damage. DO NOT RUB. Get medical attention.

REACTIVITY DATA

Stability—Will react with acids and alkyl halides.

Compatibility—Materials: Usual materials of construction are suitable.

Cargo: Group 30 of compatibility chart.

SPILL OR LEAK PROCEDURE

Wear rubber gloves, face shield and protective clothing. Have all purpose canister mask available. Keep concentration of leaking gas below explosive mixture range by ventilation. Secure ignition sources. Do not flush spill into confined spaces where flammable vapors can accumulate.

If a spill occurs, call the National Response Center, 800-424-8802.

Remarks: * Some data are undeterminable because this category considers mixture of butylenes.
‡ Unassigned

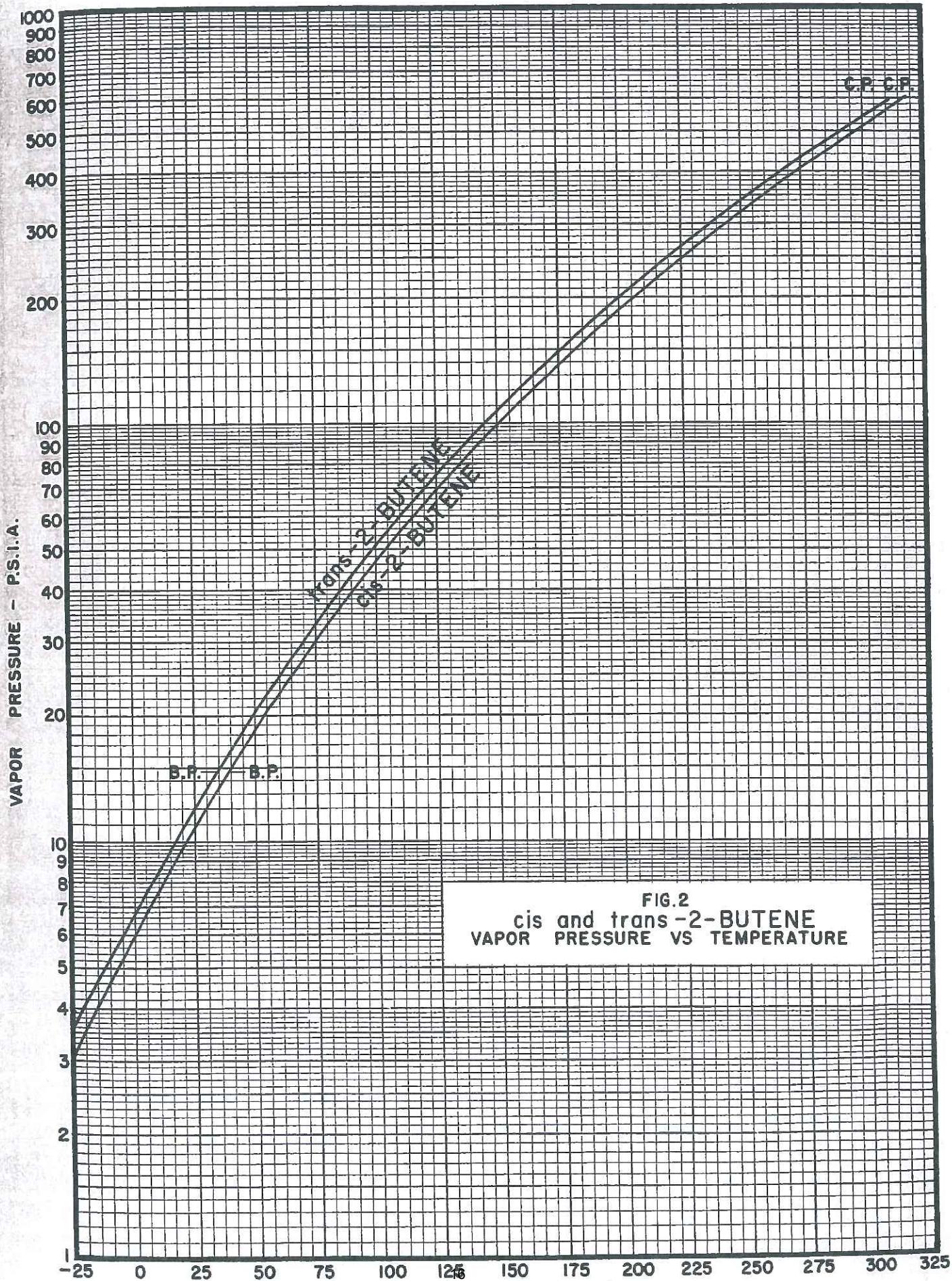
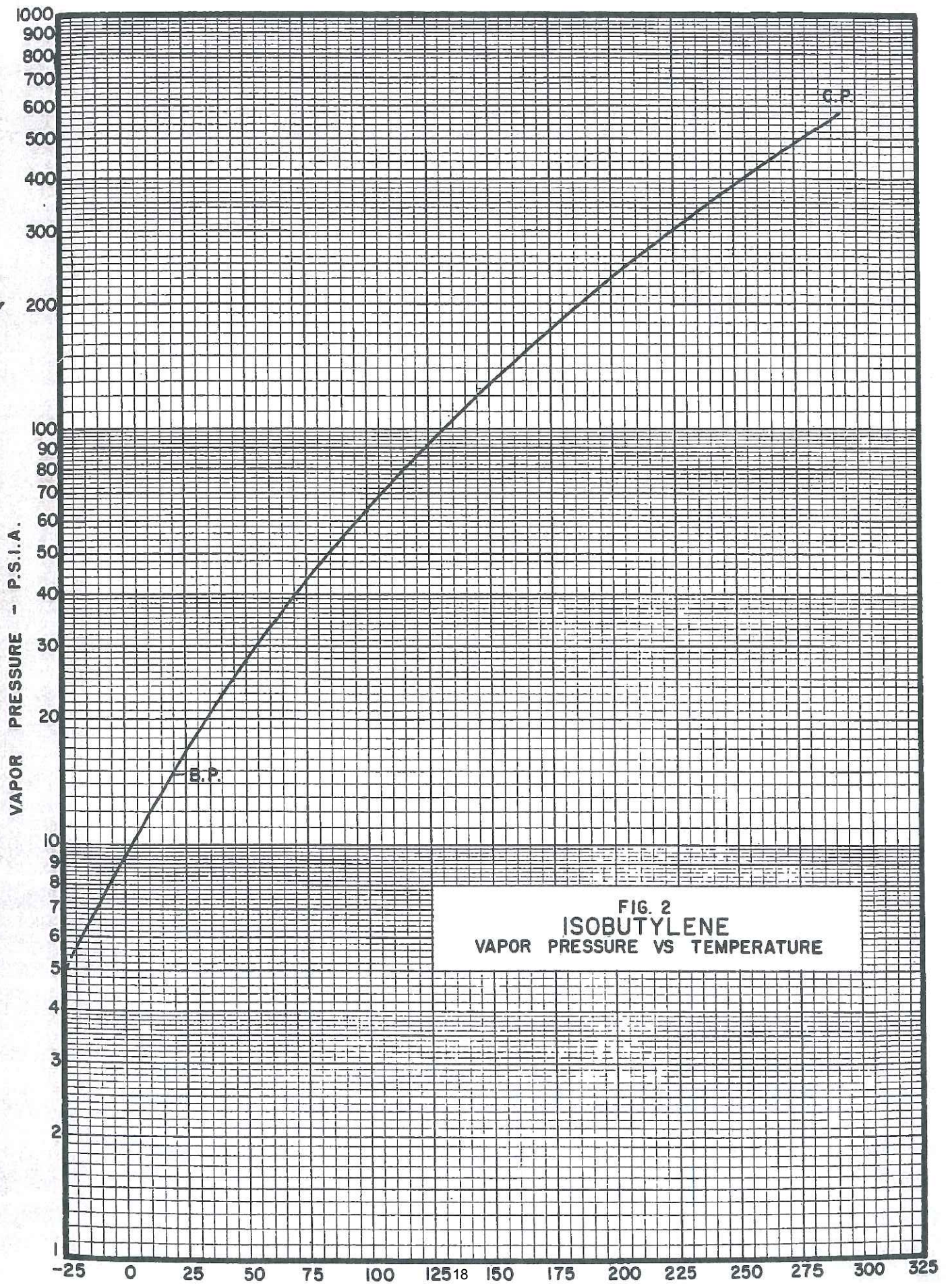

FIG.2
 cis and trans -2-BUTENE
 VAPOR PRESSURE VS TEMPERATURE

ISOBUTYLENE

Table 1. THERMODYNAMIC PROPERTIES OF SATURATED ISOBUTYLENE¹

Temp. °F.	Pressure P.S.I.A.	Specific Volume		Enthalpy		Latent Heat BTU/lb.	Entropy	
		Liquid cu. ft./lb.	Vapor cu. ft./lb.	Liquid BTU/lb.	Vapor BTU/lb.		Liquid BTU/lb. °R.	Vapor BTU/lb. °R.
-20	5.68	0.02463	14.54	173.1	350.9	177.8	0.775	1.179
-10	7.36	.02486	11.46	178.2	354.0	175.8	.791	1.182
0	9.40	.02510	9.10	183.4	357.1	173.7	.807	1.184
5	10.58	.02522	7.32	186.0	358.6	172.6	.815	1.186
10	11.88	.02535	6.60	188.6	360.1	171.5	.822	1.187
15	13.29	.02547	5.96	191.2	361.7	170.5	.829	1.188
20	14.83	.02560	5.39	193.8	363.2	169.4	.837	1.190
25	16.51	.02573	4.39	196.4	364.8	168.4	.844	1.191
30	18.33	.02587	4.89	199.0	366.3	167.3	.850	1.192
35	20.31	.02600	4.45	201.6	367.9	166.3	.857	1.193
40	22.43	.02614	4.06	204.2	369.4	165.2	.863	1.194
45	24.74	.02628	3.70	206.9	370.9	164.0	.870	1.195
50	27.22	.02642	3.39	209.6	372.4	162.8	.877	1.197
55	29.89	.02657	3.10	212.3	373.9	161.6	.884	1.198
60	32.74	.02672	2.85	215.0	375.4	160.4	.890	1.199
65	35.79	.02687	2.62	217.7	376.9	159.2	.897	1.200
70	39.05	.02702	2.41	220.5	378.4	157.9	.903	1.201
75	42.54	.02718	2.22	223.3	379.9	156.6	.909	1.202
80	46.25	.02735	2.05	226.1	381.4	155.3	.915	1.203
85	50.21	.02751	1.90	228.9	382.9	154.0	.921	1.204
90	54.42	.02768	1.76	231.7	384.4	152.7	.927	1.205
95	58.89	.02785	1.63	234.5	385.9	151.4	.933	1.206
100	63.64	.02803	1.51	237.3	387.4	150.1	.939	1.207
110	73.99	.02840	1.30	243.1	390.4	147.3	.950	1.208
120	85.58	.02880	1.13	248.9	393.2	144.3	.961	1.210
130	98.48	.02921	0.980	255.0	396.0	141.0	.972	1.211
140	112.8	.02965	.853	261.3	398.8	137.5	.983	1.212
150	128.6	.03011	.744	267.8	401.4	133.6	.994	1.213
170	165.1	.03117	.572	280.6	406.5	125.9	1.015	1.215
190	208.7	.03245	.444	293.7	411.2	117.5	1.034	1.215
210	260.1	.03400	.346	307.8	415.6	107.8	1.054	1.215
230	320.3	.03587	.268	323.0	419.4	96.4	1.074	1.214
250	390.4	.0385	.204	340.1	421.8	81.7	1.096	1.211
270	471.4	.0430	.145	358.9	420.2	61.3	1.123	1.207
292.5	580.2	.0681	.0681	404.6	404.6	0	1.188	1.188



PROPANE

Table 1. THERMODYNAMIC PROPERTIES OF SATURATED PROPANE¹

Temp. °F.	Pressure p.s.i.a.	Specific Volume Liquid cu. ft./lb.	Specific Volume Vapor cu. ft./lb.	Enthalpy		Latent Heat BTU/lb.	Entropy		Temp. °F.
				Liquid BTU/lb.	Vapor BTU/lb.		Liquid BTU/lb. °R.	Vapor BTU/lb. °R.	
-80	5.65	0.0265	16.2	162.6	354.0	191.4	0.8794	1.3832	-80
-70	7.48	.0268	12.5	167.6	357.0	189.4	.8927	1.3781	-70
-60	9.78	.02703	9.77	172.7	360.0	187.3	.9060	1.3740	-60
-50	12.60	.02733	7.73	177.8	362.8	185.0	.9188	1.3702	-50
-40	16.00	.02763	6.16	183.0	365.7	182.7	.9315	1.3670	-40
-30	20.18	.02794	5.02	188.4	368.6	180.2	.9441	1.3640	-30
-20	25.05	.02826	4.06	193.8	371.5	177.7	.9568	1.3610	-20
-10	30.95	.02859	3.33	199.4	374.4	175.0	.9690	1.3582	-10
0	37.81	.02893	2.74	205.0	377.2	172.2	.9812	1.3555	0
10	45.85	.02930	2.30	210.7	380.0	169.3	.9932	1.3531	10
20	55.00	.02970	1.93	216.6	382.6	166.0	1.0050	1.3510	20
30	65.70	.03011	1.60	222.3	385.1	162.8	1.0167	1.3491	30
40	77.80	.03055	1.33	227.9	387.5	159.6	1.0283	1.3473	40
50	91.50	.03101	1.14	233.8	389.9	156.1	1.0398	1.3456	50
60	106.9	.03150	0.984	239.6	392.2	152.6	1.0511	1.3441	60
70	124.3	.03209	.854	245.7	394.4	148.7	1.0624	1.3427	70
80	143.6	.03269	.745	251.9	396.4	144.5	1.0737	1.3413	80
90	165.0	.03329	.643	258.2	398.3	140.1	1.0850	1.3400	90
100	188.7	.03390	.558	264.6	400.2	135.6	1.0963	1.3388	100
110	214.8	.03452	.487	271.1	401.9	130.8	1.1080	1.3378	110
120	243.4	.03532	.426	278.0	403.8	125.8	1.1195	1.3368	120
130	274.5	.03612	.370	285.2	405.4	120.2	1.1310	1.3356	130
140	308.4	.03702	.320	292.7	407.0	114.3	1.1430	1.3347	140
150	345.4	.03817	.278	300.2	408.2	108.0	1.1552	1.3326	150
160	385.0	.03962	.240	308.4	408.8	100.4	1.1680	1.3303	160
170	426.0	.04132	.208	317.5	408.6	91.1	1.1816	1.3272	170
180	473.2	.04367	.180	327.5	407.6	80.1	1.1970	1.3223	180
190	523.4	.04712	.149	339.2	404.6	65.4	1.2140	1.3156	190
200	575.0	.0521	.113	353.5	398.3	44.8	1.2360	1.3040	200

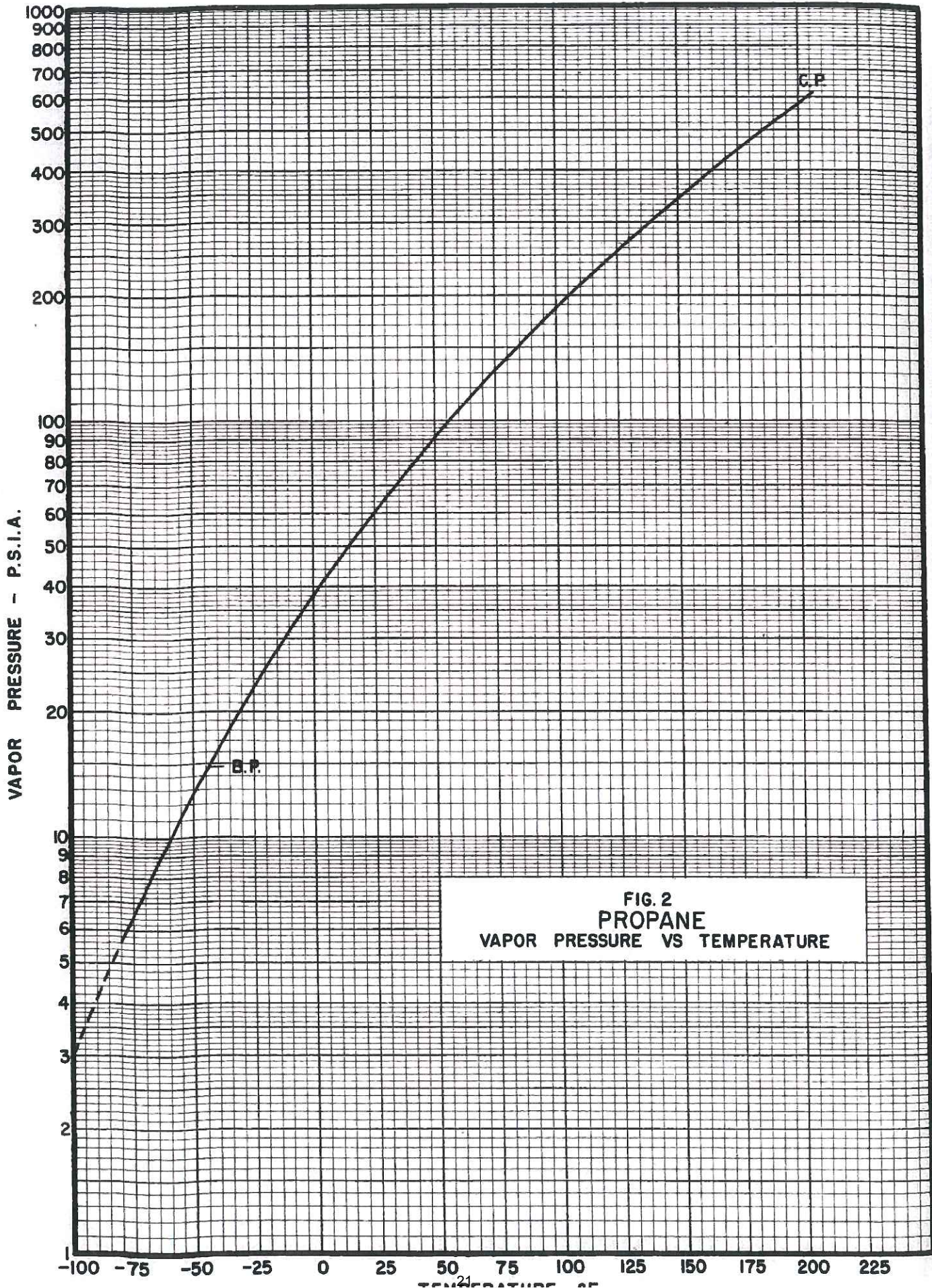

FIG. 2
PROPANE
VAPOR PRESSURE VS TEMPERATURE

PROPYLENE

<p>Synonyms—Methylethene; Methyl ethylene; Propane</p> <p>Formula—$CH_3CH=CH_2$</p> <p>Appearance-Odor—Colorless gas, liquid under pressure; characteristic olefin (gassy) odor</p> <p>Specific Gravity—0.52 at 20°C</p> <p>Chemical Family—Olefin</p> <p>Pollution Category—USEPA _____ IMO <u>099</u></p> <p>Applicable Bulk Reg. 46 CFR Subchapter _____ <u>D.O.</u></p>	<p>United Nations Number..... <u>1077</u></p> <p>CHRIS Code..... <u>PPL</u></p> <p>Boiling Point..... <u>-48°C</u> <u>-54°F</u></p> <p>Freezing Point..... <u>-185°C</u> <u>-301°F</u></p> <p>Vapor Pressure 20°C (68°F) (mmHg)..... <u>7840</u></p> <p>Reid Vapor Pressure (psia)..... <u>227.2</u></p> <p>Vapor Pressure 46°C (115°F) (psia)..... <u>273.0</u></p> <p>Vapor Density (Air = 1.0)..... <u>1.48</u></p> <p>Solubility in Water..... <u>45 ml gas/100 ml water</u></p>
---	---

FIRE & EXPLOSION HAZARD DATA

Grade—Liquefied Flammable Gas (LFG)
Electrical Group—D

General—As with all gas fires, the only effective method of extinguishing is to shut off the fuel supply. Otherwise a more dangerous situation, the formation of an explosive mixture can result.

Flash Point (°F)..... -182
Flammable Limits..... 2.0 to 11.0%
Autoignition Temp. (°F)..... 927
Extinguishing Agents..... Stop flow of gas; water fog
Special Fire Procedures..... Tanks exposed to fire should be kept cool with a water spray.

HEALTH HAZARD DATA

Health Hazard Ratings	Odor Threshold (ppm)	PEL/TWA (ppm)	TLV/TWA (ppm)
0, 0, 1	Unavailable	Unavailable	Unavailable

General—Simple asphyxiant. Absence of adequate warning indications such as strong odor or pronounced irritation of mucous membranes of eyes and nose introduces possibility of exposure to hazardous concentrations. Contact with the liquid may cause frostbite.

Symptoms—Dizziness, sleepiness

Short Exposure Tolerance—Mixture of 6.4% propylene and 28% oxygen inhaled for 2 1/4 minutes produces mild intoxication, drowsiness, tingling of the skin, and inability to concentrate.

Exposure Procedures—Remove victim to fresh air. Apply artificial respiration if breathing stops. Contact with liquid may cause frostbite. If the liquid has spilled onto the skin, points of contact may be frostbitten; handle gently and protect from mechanical damage. DO NOT RUB. Get medical attention.

REACTIVITY DATA

Stability—Stable at ordinary temperatures.

Compatibility—Material: Usual materials of construction may be used.

Cargo: Group 30 of compatibility chart.

SPILL OR LEAK PROCEDURE

Have all-purpose canister mask available. Shut off ignition sources. Call the fire department. If product does not catch fire, it will soon boil off.

If a spill occurs, call the National Response Center, 800-424-8801.

Remarks:

PROPYLENE

Table 1. THERMODYNAMIC PROPERTIES OF SATURATED PROPYLENE²

Temp. °F.	Pressure atm.	Specific Volume Liquid cu. ft./lb.	Specific Volume Vapor cu. ft./lb.	Enthalpy		Latent Heat BTU/lb.	Entropy		Temp. °F.
				Liquid BTU/lb.	Vapor BTU/lb.		Liquid BTU/lb. °R.	Vapor BTU/lb. °R.	
-53.86	1.000	0.02610	6.774	265.81	454.0	188.19	0.9543	1.418	-53.86
-50	1.102	0.02627	6.194	268.20	455.4	187.20	0.9591	1.416	-50
-40	1.401	0.02659	4.936	273.48	458.04	184.56	0.9723	1.412	-40
-30	1.761	0.02691	4.015	278.66	460.49	181.83	0.9849	1.408	-30
-20	2.187	0.02723	3.284	283.89	462.89	179.00	0.9979	1.405	-20
-10	2.686	0.02771	2.713	289.08	465.13	176.05	1.0096	1.401	-10
0	3.263	0.02803	2.255	294.50	467.47	172.97	1.0218	1.398	0
10	3.932	0.02835	1.885	300.01	469.76	169.75	1.0336	1.395	10
20	4.984	0.02883	1.586	305.56	471.94	166.38	1.0452	1.392	20
30	5.575	0.02915	1.343	311.18	474.02	162.84	1.0565	1.389	30
40	6.568	0.02963	1.142	316.84	476.95	159.11	1.0676	1.386	40
50	7.685	0.03011	0.976	322.81	478.97	156.16	1.0786	1.383	50
60	8.939	0.03075	0.838	328.46	479.44	150.98	1.0895	1.380	60
70	10.336	0.03124	0.722	334.40	481.96	147.56	1.1003	1.377	70
80	11.888	0.03172	0.624	340.30	482.21	141.91	1.1121	1.375	80
90	13.599	0.03236	0.543	346.46	483.48	137.02	1.1228	1.372	90
100	15.486	0.03300	0.472	352.66	484.56	131.90	1.1338	1.369	100
110	17.552	0.03380	0.412	358.81	485.35	126.54	1.1444	1.367	110
120	19.814	0.03460	0.360	365.11	485.99	120.88	1.1550	1.364	120
130	22.286	0.03572	0.314	371.19	486.39	115.20	1.1650	1.360	130
140	24.978	0.03700	0.274	377.88	486.62	108.74	1.1757	1.357	140
150	27.914	0.03844	0.237	385.06	486.06	101.00	1.1876	1.353	150
160	31.095	0.04021	0.203	393.55	485.04	91.49	1.2008	1.348	160
170	34.547	0.04197	0.170	403.72	483.47	79.75	1.2157	1.342	170
180	38.293	0.04469	0.138	415.22	480.53	65.31	1.2329	1.335	180
190	42.385	0.04982	0.106	430.14	473.73	43.59	1.2595	1.327	190
197.17	45.609	0.07271	0.07271	457.85	457.85	0	1.2962	1.2962	197.17

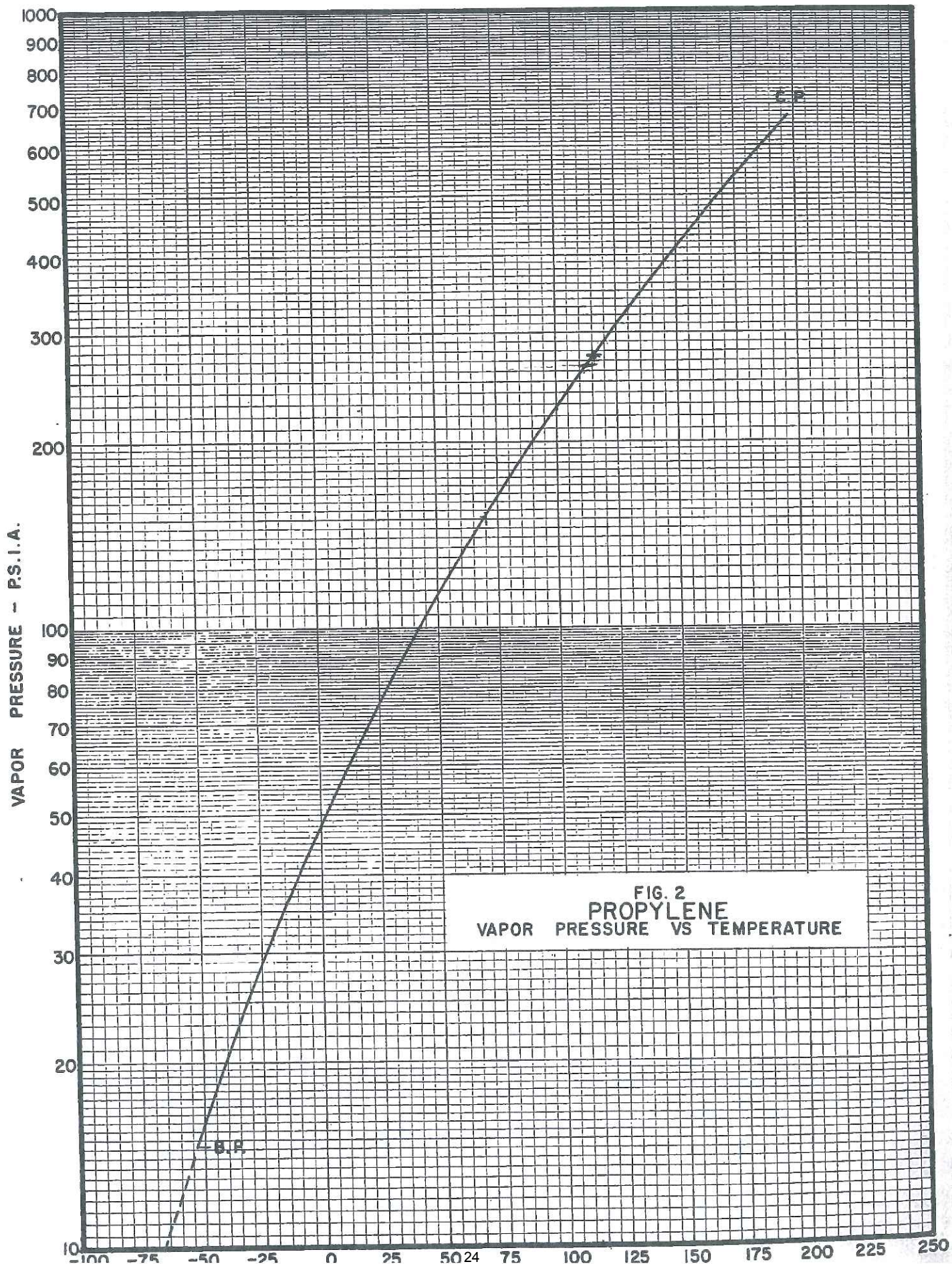

SECTION 155.750(a)(2):

PIPING DIAGRAM

This section complies with 33 CFR 155.750 (a) (2) with regard to the piping diagram. It includes the following:

1. Piping diagram
2. Explanation of symbols to Piping Diagram

BOW

PORT

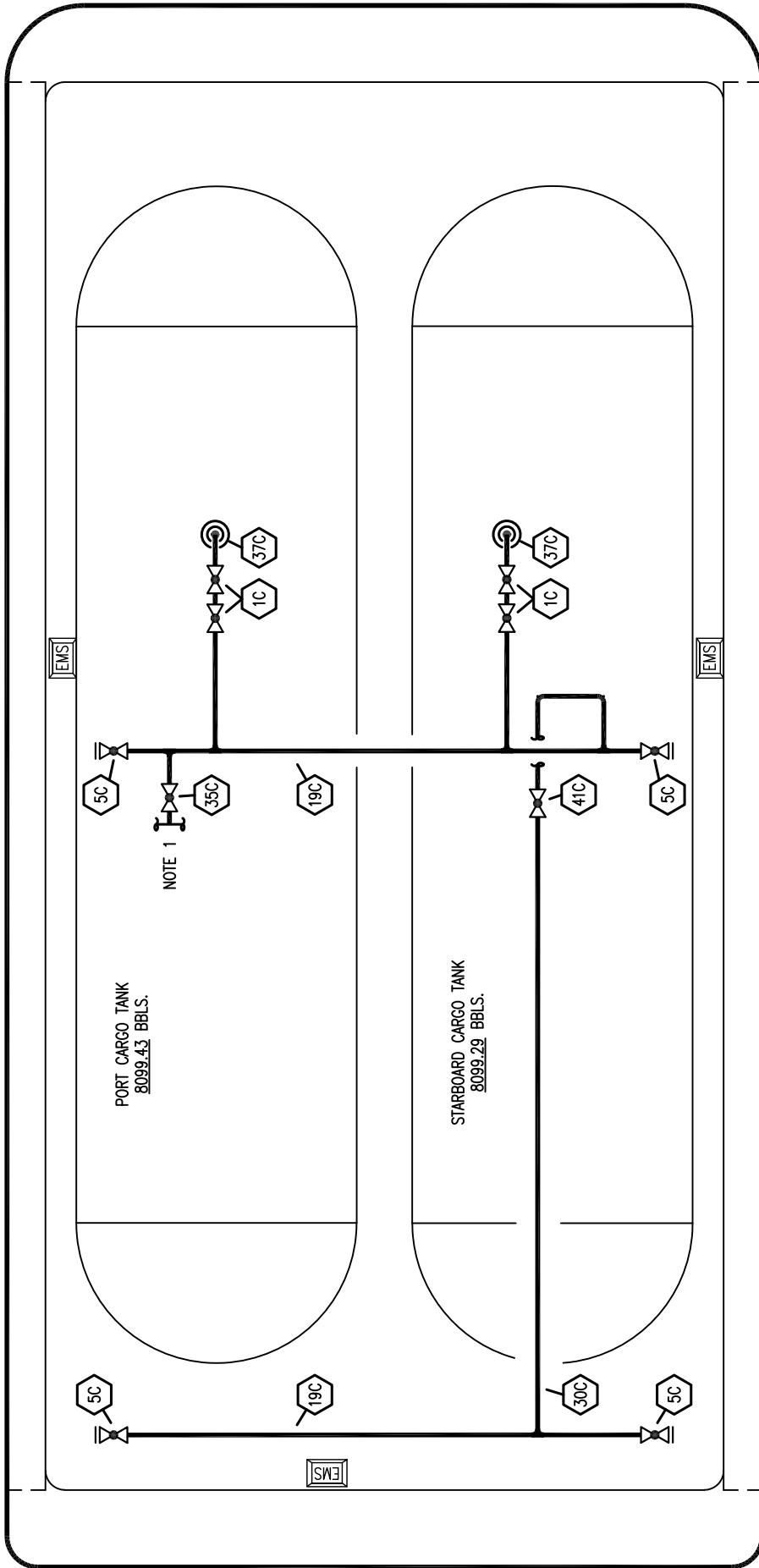

STERN

STARBOARD

- | | |
|---------------------|------------------|
| NO. | DESCRIPTION |
| 1C | CARGO TANK VALVE |
| 5C | HEADER VALVE |
| 19C | CARGO HEADER |
| 30C | CARGO PIPELINE |
| 35C | CROSSOVER VALVE |
| 37C | CARGO DROP |
| 41C | BLOCK VALVE |
| — ABOVE DECK PIPING | |

NOTE 1: CONTINUED ON VAPOR DWG.

TRINITY MARINE – EX: HW CHEM 167

REV.	DATE	BY	CHK	APP	REVISION DESCRIPTION
2	03/08/23	MRV	DDA	RM	REVISED PER CLIENT COMMENTS
1	10/28/13	DCB	DDA		RELOCATED 41C
0	10/19/09	LT	RB	OF	APPROVED



CARGO

PIPING FLOW DIAGRAM

SCALE: NONE
PAGE: 1 OF 2

KIRBY 16806

REV. **2**

BOW

PORT

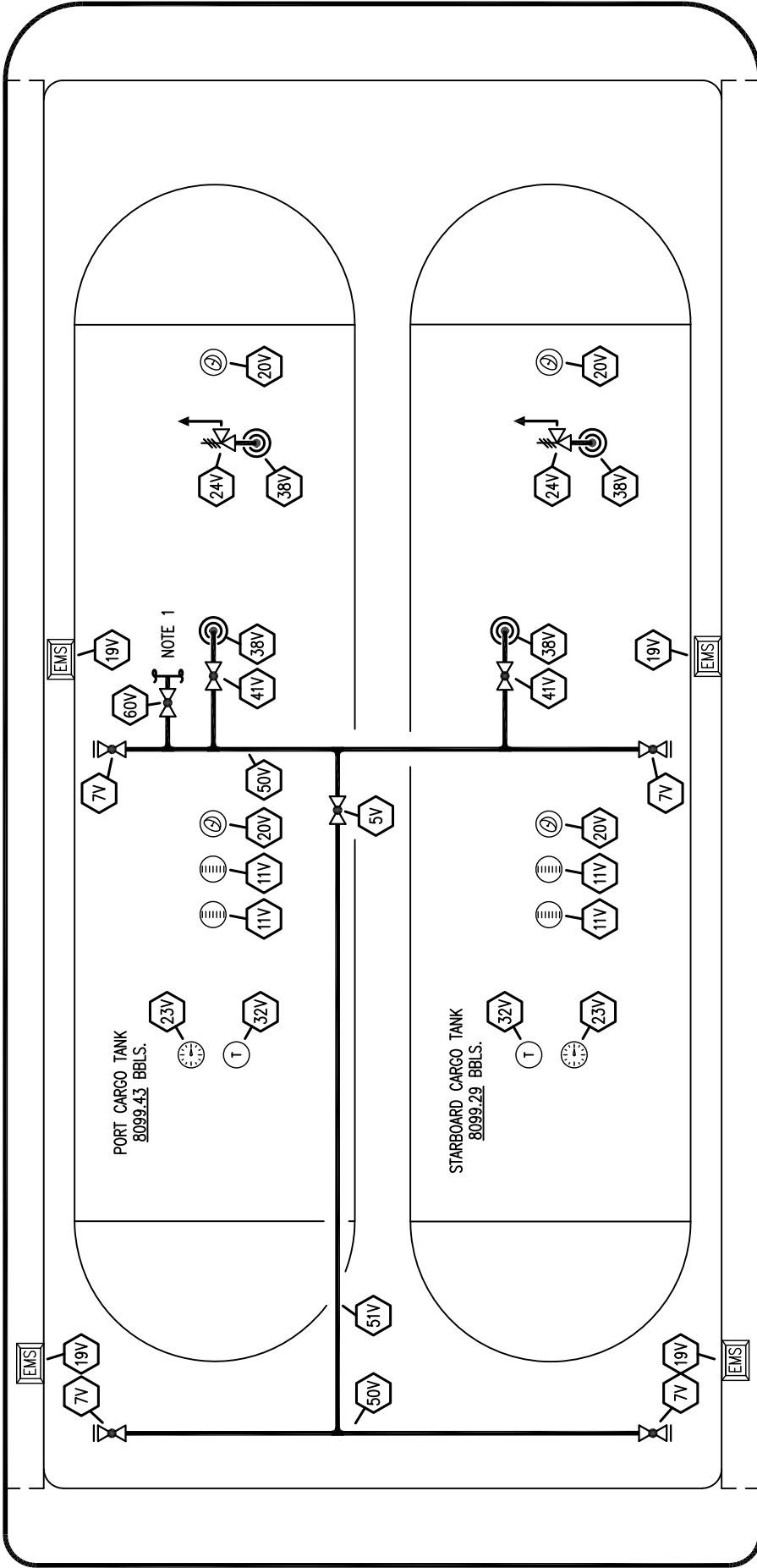

STERN

STARBOARD

NOTE 1: CONTINUED ON CARGO DWG.

- | | | | |
|-----|-----------------------------|-----|-------------------|
| NO | DESCRIPTION | NO | DESCRIPTION |
| 5V | BLOCK VALVE | 41V | VAPOR TANK VALVE |
| 7V | HEADER VALVE | 50V | VAPOR HEADER |
| 11V | 1-METER STICK GAUGE | 51V | VAPOR PIPELINE |
| 19V | EMERGENCY SHUT DOWN | 60V | CROSSOVER VALVE |
| 20V | CALIBRATED RADAR GAUGING | — | ABOVE DECK PIPING |
| 23V | PRESSURE GAUGE | | |
| 24V | PRESSURE RELIEF VALVE/STACK | | |
| 32V | TEMPERATURE GAUGE | | |
| 38V | VAPOR PENETRATION | | |

TRINITY MARINE - EX: HW CHEM 167



KIRBY INLAND MARINE

VAPOR

PIPING FLOW DIAGRAM

REV.	DATE	BY	CHK	APP	REVISION DESCRIPTION
2	03/08/23	MRV	DDA	RM	REVISED PER CLIENT COMMENTS
1	10/28/13	DCB	DDA		REMOVED 65V
0	10/19/09	LT	RB	OF	APPROVED

SECTION 155.750(a)(3):

NUMBER OF PERSONS ON DUTY

No person shall act as the person in charge of transfer operations on more than one vessel at a time during transfers between vessels or between two or more vessels and a facility unless authorized by the Captain of the Port. This authorization will be in writing and made part of the transfer procedure. The person in charge shall be a certified tankerman who must hold an LFG endorsement. The person in charge shall be aboard the barge at all times unless he is properly relieved or transfer operations have stopped.

SECTION 155.750(a)(4):

DUTIES OF TANKERMAN (PERSON IN CHARGE)

The tankerman (person in charge) is responsible for transferring barge and carrying out related operations on board in an efficient, safe, and pollution free manner.

The tankerman (person in charge) shall:

1. Have on board a valid merchant mariners document endorsed as tankerman, certified to handle LFG.
2. Make a thorough inspection of the barge prior to the start of the transfer and check the following:
 - a. Hull condition
 - b. Pressure and Temperature Gauge accuracy
 - c. Any valve or safety valve leakage
 - d. Fire extinguisher condition and number
 - e. Piping Diagram and Strappings for correctness and completeness
 - f. Warning signs, flag, night warning light, shut down sign
 - g. Condition of shutdowns and air control system valves and regulators
 - h. Operability of closed stick gauges
3. In addition the tankerman shall ensure that:
 - a. The vessel's moorings are strong enough to hold during all expected conditions of surge, current, and are long enough to allow for changes in draft, drift, and tide.
 - b. The hoses are long enough to allow the vessels to move within the limits of its moorings without placing a strain on the hose loading arm or piping systems.

SECTION 155.750(a)(4) continued:

- c. Each hose is supported to prevent chaffing kinking, or other damages to the hose or hose couplings.
- d. Each transfer system is aligned to allow the flow of cargo.
- e. Each part of the transfer system not in use is securely blanked or shut off.
- f. Each end of hose or loading arm that is not in use is securely blanked by using a bolt in every hole.
- g. Each hose has no loose covers, kinks, bulges, soft spots, gouges, cuts, or slashes that penetrate the first layer of hose reinforcement.
- h. All connections in the transfer system are leak free.
- i. The communications required for the transfer system are leak free.
- j. Tankerman is at the site of the transfer and immediately available.
- k. Transfer is conducted in accordance with the vessel transfer procedure.
- l. Tankerman has a copy of transfer procedure in possession.
- m. Tankerman and dock person in charge both speak English.
- n. A pre-transfer conference is held with the person in charge of the dock facility and the person understands the following details of the transfer:
 - 1) The identity of the product being transferred
 - 2) The sequence of transfer operations
 - 3) The transfer rate
 - 4) The name, or title, and location of each person involved in the transfer operations
 - 5) Details of the transferring and receiving system

SECTION 155.750(a)(4) continued:

- 6) Critical stages of the transfer operations
 - 7) Federal, state, and local rules that apply to the transfer
 - 8) Emergency procedure
 - 9) Discharge mitigation and containment procedures
 - 10) Discharge reporting procedures
 - 11) Watch or shift change arrangements
 - 12) Transfer shutdown procedures
- o. The Persons in charge of transfer operations for the vessel and facility must agree on the transfer operations prior to transfer.
 - p. The transfer operation is lighted between sunset and sunrise.

SECTION 155.750(a)(5):

TENDING VESSEL MOORINGS DURING TRANSFER OPERATIONS

Proper mooring of the barge is essential for both safety and pollution prevention. You may not transfer cargo to or from a barge unless its moorings are strong enough to hold in all expected conditions of surge, current, and weather. The mooring lines must be long enough to allow for changes in draft, trim, surge, and tide during transfer operations.

All conditions at the dock must be considered to determine the adequate size, proper lead and the number of lines necessary. Surge of the barge, both at parallel to and at right angles to the dock, will be influenced by the proximity of traffic in the channel, the dock design, the state of the tide and the barge's draft. Be sure that all lines have the proper lead and are secure.

Be particularly mindful of docks with high and low mooring dolphins, etc. It may be necessary to shift from lower mooring supports to higher or visa versa, as the barge goes down or comes up from the water.

When mooring the barge, as a MINIMUM standard, the PIC should ensure that the number of mooring lines used is in accordance with the governing Standard Operating Procedures for the service of this barge. The lines are used in combination to fulfill the following functions:

- (1) Towing lines
- (2) Backing lines
- (3) Spring lines

SECTION 155.750(a)(6):

EMERGENCY SHUTDOWN AND COMMUNICATIONS

The valving system contains air diaphragm control valves throughout, with the exception of a manual valve closest to the tank entrance for the liquid and vapor lines.

NOTE: These manual valves are adjacent to the air operated valves, thus each vapor and liquid line has two valves as close to the tank penetration as possible. The air diaphragm valves are opened by application of air pressure against their diaphragms.

The control valves throughout the barge can be opened by controlling a four way valve at each control station. Suitable block valves are located in the air control system in order to keep some valves closed if desired.

The air control system for this barge is designed with special dump valves at each control valve to ensure total closure time is within 10 seconds. By pulling the cable at the four way valve at any station, all control valves will close within 10 seconds.

The control system is also designed to allow local closure at a particular control valve without having to dump the entire system. This valving arrangement is located at the particular control valve.

Each vessel must have a means that enables continuous two way voice communications between the facility and vessel persons in charge. This means must be usable and effective in all phases of the transfer operation and in all conditions of weather.

The means of communication may be a two way radio or a loud hailer and must be intrinsically safe as defined in 46 CFR 110 and meet Class 1, Division 1, Group D.

SECTION 155.750(a)(7):

PROCEDURES FOR TOPPING OFF TANKS AND DISCHARGE OPERATIONS

The load limits for LG barges are based on authorized Type II draft limitations, or volumetric capacities based on filling densities, whichever comes first. It is anticipated that at all loading temperatures, the percentage based on filling density will be reached before the authorized barge draft is obtained.

Filling density limits vary with temperature and pressure of the LG cargo when loaded. Well before the topping off stage, at about 75% to 80% full, the temperature of the LG cargo will stabilize. Take this temperature and refer to the chart in these procedures for the specific LG product. At the given temperature, take the load % and refer to the strappings to determine the correct amount in "topping off."

Remember, load to the designated FILLING PERCENTAGE of MEAN MIDSHIP DRAFT, whichever comes first. If the COI draft is obtained before the % of fill, then check to ensure that this is the mean midship draft and not the point at which one end of the barge first reaches the COI draft. Also check to see if water is in the hopper or voids.

Any unresolved situations where COI draft is reached before the loading % should be reported to the appropriate Kirby Inland Marine authorities, who hopefully will take measures to legally correct the problem with the USCG for the future.

Remember, any OPERATIONAL draft restriction placed upon you by the company due to the water depth will supersede the USCG loading % and mean draft requirements, if this draft is less than what the COI authorizes. In this case, you might have to terminate the load at the point where the barge first reaches the depth limit in order to avoid rubbing bottom. LG barges are hard to load to an even trim.

The remaining pages in this section of the procedures give the filling % as a function of topping off temperature.

SECTION 155.750(a)(7) continued:

For discharge operations, since pumps are not installed on the barge, either an inert gas or cargo vapors must be provided from the terminal through the vapor line as the pressurizing medium to allow for cargo discharge. The safety relief valves on the pipelines are set much higher than the safety relief valves on the cargo tanks. This is USCG approved to ensure that venting of product trapped in the pipelines does not easily occur. PIC's should not mistake this higher pipeline pressure setting to allow more pressure on the system to help discharge the barge. PIC's are bound by the cargo tank relief valve setting of 260 psig, or better yet, about 90% of it or 235 psig. DO not exceed the tank design pressure, regardless of the higher pressure setting which applies for the pipelines.

BUTADIENE

(FILLING DENSITY .59)

VOLUMETRIC TANK CAPACITIES

VS.

TEMPERATURE

TEMP (F)	SEPCIFIC VOLUME (H ₂ O) FT ³ /LB	SPECIFIC VOLUME (LFG) FT ³ /LB	% VOLUME USING LIQUID FULL @ 115°F
40	.01602	.02503	91.7
50	.01602	.02529	92.6
60	.01603	.02557	93.7
70	.01605	.02585	94.7
80	.01607	.02614	95.8
90	.01610	.02645	96.9
100	.01613	.02678	98.1
110	.01617	.02713	99.4
115	.016185	.02730	100.0

NOTE:

% volume by the liquid full at 115°F criteria is found by ensuring that the ratios of specific LFG volumes between successive temperature intervals equal the ratio of volumetric %, with the starting point assuming a liquid full tank at 115°F

BUTANE

(FILLING DENSITY .54)

VOLUMETRIC TANK CAPACITIES VS. TEMPERATURE

TEMP (F)	SEPCIFIC VOLUME (H ₂ O) FT ³ /LB	SPECIFIC VOLUME (LFG) FT ³ /LB	% VOLUME USING LIQUID FULL @ 115°F
40	.01602	.02690	92.5
50	.01602	.02718	93.4
60	.01603	.02745	94.4
70	.01605	.02776	95.4
80	.01607	.02808	96.5
90	.01610	.02841	97.7
100	.01613	.02873	98.8
110	.01617	.02892	99.4
115	.016185	.02909	100.0

NOTE:

% volume by the liquid full at 115°F criteria is found by ensuring that the ratios of specific LFG volumes between successive temperature intervals equal the ratio of volumetric %, with the starting point assuming a liquid full tank at 115°F

ISOBUTANE

(FILLING DENSITY .52)

VOLUMETRIC TANK CAPACITIES VS. TEMPERATURE

TEMP (F)	SEPCIFIC VOLUME (H ₂ O) FT ³ /LB	SPECIFIC VOLUME (LFG) FT ³ /LB	% VOLUME USING LIQUID FULL @ 115°F
40	.01602	.02778	91.2
50	.01602	.02810	92.2
60	.01603	.02843	93.3
70	.01605	.02876	94.4
80	.01607	.02909	95.5
90	.01610	.02947	96.7
100	.01613	.02986	98.0
110	.01617	.03006	98.6
115	.016185	.03047	100.0

NOTE:

% volume by the liquid full at 115°F criteria is found by ensuring that the ratios of specific LFG volumes between successive temperature intervals equal the ratio of volumetric %, with the starting point assuming a liquid full tank at 115°F

BUTYLENE

(FILLING DENSITY .56)

VOLUMETRIC TANK CAPACITIES

VS.

TEMPERATURE

TEMP (F)	SEPCIFIC VOLUME (H ₂ O) FT ³ /LB	SPECIFIC VOLUME (LFG) FT ³ /LB	% VOLUME USING LIQUID FULL @ 115°F
40	.01602	.02610	90.8
50	.01602	.02638	91.8
60	.01603	.02667	92.8
70	.01605	.02698	93.8
80	.01607	.02730	95.1
90	.01610	.02770	96.3
100	.01613	.02811	97.8
110	.01617	.02852	99.2
115	.016185	.02875	100.0

NOTE:

% volume by the liquid full at 115°F criteria is found by ensuring that the ratios of specific LFG volumes between successive temperature intervals equal the ratio of volumetric %, with the starting point assuming a liquid full tank at 115°F

ISOBUTYLENE

(FILLING DENSITY .56)

VOLUMETRIC TANK CAPACITIES

VS.

TEMPERATURE

TEMP (F)	SEPCIFIC VOLUME (H ₂ O) FT ³ /LB	SPECIFIC VOLUME (LFG) FT ³ /LB	% VOLUME USING LIQUID FULL @ 115°F
40	.01602	.02614	91.4
50	.01602	.02642	92.4
60	.01603	.02672	93.4
70	.01605	.02702	94.5
80	.01607	.02735	95.6
90	.01610	.02768	96.8
100	.01613	.02803	98.0
110	.01617	.02840	99.3
115	.016185	.02860	100.0

NOTE:

% volume by the liquid full at 115°F criteria is found by ensuring that the ratios of specific LFG volumes between successive temperature intervals equal the ratio of volumetric %, with the starting point assuming a liquid full tank at 115°F

PROPANE

(FILLING DENSITY .45)

VOLUMETRIC TANK CAPACITIES

VS.

TEMPERATURE

TEMP (F)	SEPCIFIC VOLUME (H ₂ O) FT ³ /LB	SPECIFIC VOLUME (LFG) FT ³ /LB	% VOLUME USING LIQUID FULL @ 115°F
40	.01602	.03055	87.5
50	.01602	.03101	88.9
60	.01603	.03150	90.2
70	.01605	.03209	92.0
80	.01607	.03269	94.2
90	.01610	.03329	95.3
100	.01613	.03390	97.1
110	.01617	.03452	98.8
115	.016185	.03492	100.0

NOTE:

% volume by the liquid full at 115°F criteria is found by ensuring that the ratios of specific LFG volumes between successive temperature intervals equal the ratio of volumetric %, with the starting point assuming a liquid full tank at 115°F

PROPYLENE

(FILLING DENSITY .47)

VOLUMETRIC TANK CAPACITIES

VS.

TEMPERATURE

TEMP (F)	SEPCIFIC VOLUME (H ₂ O) FT ³ /LB	SPECIFIC VOLUME (LFG) FT ³ /LB	% VOLUME USING LIQUID FULL @ 115°F
40	.01602	.02963	86.6
50	.01602	.03011	88.0
60	.01603	.03075	90.0
70	.01605	.03124	91.3
80	.01607	.03172	92.7
90	.01610	.03236	94.6
100	.01613	.03300	96.5
110	.01617	.03380	98.8
115	.016185	.03420	100.0

NOTE:

% volume by the liquid full at 115°F criteria is found by ensuring that the ratios of specific LFG volumes between successive temperature intervals equal the ratio of volumetric %, with the starting point assuming a liquid full tank at 115°F

LIQUIFIED FLAMMABLE GASES

Maximum Safe Loading Percentage by Cargo and Temperature

Temp F°	Butadiene	Butane	Isobutane	Butylene	Isobutylene	Propane	Propylene
0	88.1%			87.2%	87.8%	82.8%	82.0%
10	88.9%			88.0%	88.6%	83.9%	82.9%
20	89.8%			88.9%	89.5%	85.1%	84.3%
30	90.8%			90.0%	90.5%	86.2%	85.2%
40	91.7%	92.5%	91.2%	90.8%	91.4%	87.5%	86.6%
50	92.6%	93.4%	92.2%	91.8%	92.4%	88.8%	88.0%
60	93.7%	94.4%	93.3%	92.8%	93.4%	90.2%	90.0%
70	94.7%	95.4%	94.4%	93.8%	94.5%	92.0%	91.3%
80	95.8%	96.5%	95.5%	95.0%	95.6%	94.2%	92.7%
90	96.9%	97.7%	96.7%	96.3%	96.8%	95.3%	94.6%
100	98.1%	98.8%	98.0%	97.8%	98.0%	97.1%	96.5%
110	99.4%	99.4%	98.7%	99.2%	99.3%	98.9%	98.8%
115	100.0%	100.0%	100.0%	100.0%	100.0%	100.0%	100.0%

SECTION 155.750(a)(8):

CONTROL VALVE OPERATION & CLOSURE

To Open Control Valves:

1. Connect shore air supply to control station.
2. Open manual air supply valve to air operated control valves.
3. Open the air valve in the system to each control valve desired for the operation.
4. In case of emergency pull the emergency shutdown cable at any control station.

To Close Control Valves:

1. Shut off and bleed the air pressure from the system.
2. Close all manual air supply valves in the system.
3. Close all cargo and vapor manual valves.

Cargo Hose Connections:

1. All flanges must be made up with bolts in every hole.
2. After discharge or loading, blinds are made up with bolts in every hole.

SECTION 155.750(a)(9):

PROCEDURES FOR REPORTING DISCHARGES

In the event of an LFG discharge during loading or discharging operations, the most important consideration is to locate the source and stop the discharge at the source. This will in almost all situations require the tankerman to activate the remote quick closing valve shutdowns to close off all potential flow to or discharge from the barge tanks. Notify the dock of this action in order to prevent excessive pressure buildup.

Also, since the discharge of LFG is most likely to exist in the vapor phase (since any liquid spilled will rapidly vaporize), an exclusion zone must immediately be established particularly in the downwind areas and the release is of high pressure. This means ensuring that potential ignition sources are kept away.

Once these immediate “first responder” initial actions have taken place (this should not take a great deal of time,) then proceed with the following steps:

1. Notify Kirby Inland Marine, Inc at 713-435-1195 (dispatch) who will make the reporting requirements as outlines in the spill report. Be prepared to provide the following information to the best of your ability.

NOTE: IF YOU DO NOT HAVE ALL THE INFORMATION, DON'T LET THAT DELAY YOU IN REPORTING TO THE COMPANY.

- A. Name
 - B. Company name
 - C. Name of barge
 - D. Incident location
 - E. Type of product
 - F. Estimated quantity discharge
 - G. Weather, tide, and sea conditions
 - H. Cause of the discharge
 - I. Actions taken to mitigate the discharge
2. Remember, until Kirby Response Team personnel arrive, your best actions as the “first responder” are to stop the discharge and establish and enforce the exclusion zone.

SECTION 155.750(a)(9) continued:

3. If possible, use boat equipment to rig a water spray system to knock down the vapor or at least disperse concentrations below flammable limits. This is important if the vapor cloud would be heading to areas of potential ignition sources and it is best to apply water perpendicular to the vapor flow (hit is broadside) as close to the discharge point as possible. However, if adequate personnel protection equipment is not available, then this shouldn't be done, without first checking with the Safety supervisor.

SECTION 155.750(a)(10):

PROCEDURES FOR CLOSING AND OPENING THE VESSEL OPENINGS

This is an LG barge with pressure vessel tanks at MAWP. The cargo tanks are not designed to allow any open or PV venting to the atmosphere during transfer operations in while transit. In fact, they are outfitted only with safety relief valves set at MAWP as the venting device. Any such venting needs to be reported to the appropriate Kirby Inland Marine authorities. Slip tubes in particular, are to remain closed and sealed off when not in use. Check for leaks in this area and report them.

Sometimes after a load residual product will be trapped in the pipelines. The safety relief valves on these pipelines have been set much higher than the cargo tank safety relief valve in order to minimize the transit venting of product. This is USCG approved. Nevertheless, be wary of these pipelines and their potential to vent. If they do vent, report this to the appropriate Kirby Inland Marine authorities.

The hull and hopper have voids, which could provide a great deal of space for the influx of rainwater, etc. which could compromise load limits and barge stability. Hatches over these void spaces should only be opened for inspection purposes. During the transfer, they need not be totally dogged down since the PIC will be conducting frequent inspections of the voids. After the transfer, and while in transit, they must be totally secured. If opened periodically for inspection during transit, they must be totally secured.

SECTION 155.750(a)(11):

HOSES

Cargo hoses for LG service whether provided by the barge/boat or terminal must be made of flexible metal and fabricated of seamless steel pipe and flexible joints of steel or bronze, or of other suitable material resistant to the action of the cargo.

The Maximum Allowable Working Pressure (MAWP) shall be marked on the hose. For transfers involving butadiene, butanes, butylenes, a #150 hose is OK. For propylene and propane, a rated #300 class hose is OK. Also, be aware that barges rated at 260 psig will usually have #300 flanged at the hose connection so this might have to be accounted for when using at #150 hose for the lower pressure products.

In addition to the MAWP, the date of the manufacture and date of the annually required pressure test should be marked on the hose. If not, however, this information can be contained within the barge or facility paperwork records, and the hose must be marked to indicate this.

Further, the hose must be either marked for Liquefied Gas service, or for the specific liquefied gas, or reference a chart of approved LG products in the barge or facility paperwork, where appropriate.

Ensure that the pre transfer inspection procedures for hoses as outlined in Section 155.750 (a)(4) are met.